

# 241004 TERMICUR 45

FICHA DE SISTEMA / SYSTEM DATASHEET / FICHE TECHNIQUE DU SYSTÈME / FICHA DE DADOS DO SISTEMA

312004 LAMA PF TERMICUR - 45  
312010 LAMA PF TERMICUR - 45 HD

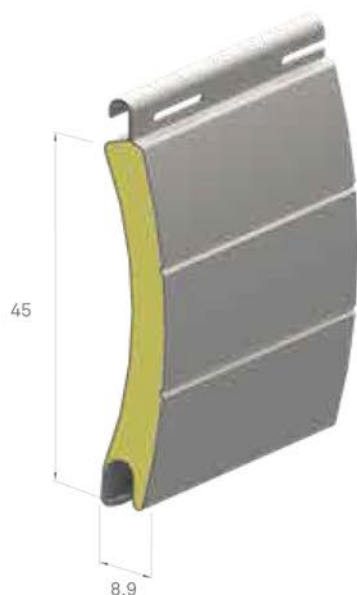

## Datos técnicos

Technical parameters / Paramètres techniques / Dados técnicos

<b>Material</b> Matière	AL + PUR	
<b>Lamas por metro de altura</b> Necessary slats per height meter Nombre de lames au mètre Lâminas por metro de altura	22,2	
<b>Superficie de cobertura (mm)</b> Surface coverage / Surface de couverture	45	
<b>Eje mínimo de enrollamiento Ø (mm)</b> Minimum rolling shaft / Axe minimal d'enroulement Eixo mínimo de enrolamento	60	
<b>Espesor aprox. (mm)</b> Nominal thickness / Épaisseur / Grossura nominal	8,0	
<b>Densidad poliuretano</b> Poliuretane density / Densité polyuréthane	90 Kg / m <sup>3</sup>	180 kg / m <sup>3</sup> HD
<b>Peso m<sup>2</sup> aprox.</b> Weight per m2 / Poids m <sup>2</sup> approximatif	2,09 kg / m <sup>2</sup>	3,1 kg / m <sup>2</sup> HD

## Resistencia al viento según UNE-EN 13659 : 2016

Wind resistance according to UNE-EN 13659 : 2016 / Résistance au vent conformément à la norme UNE-EN 13659 : 2016  
Resistência ao vento consoante a norma UNE-EN 13659 : 2016

### Poliuretano 90 ( Kg / m<sup>3</sup> )

Polyuretane density  
Densité du polyuréthane  
Densidade poliuretano

V2 : 100 Pa ≈ 46 km/h  
V3 : 150 Pa ≈ 56 km/h  
V4 : 250 Pa ≈ 78 km/h  
V5 : 400 Pa ≈ 92 km/h  
V6 : 600 Pa ≈ 112 km/h

### Guía H-25

Profundidad útil: 25 mm  
Util Depth: 25 mm  
Profondeur Util: 25 mm  
Profundidade Util: 25 mm



## ■ Perfiles

Porfiles / Porfils / Perfis

Código Code	Densidad poliuretano ( Kg / m <sup>3</sup> ) Polyurethane density Densité du polyuretane Densidade poliuretano	Peso m. lineal ( Kg ) Weight per linear meter Poids par mètre linéaire Peso linear	Peso por m. ( Kg / m <sup>2</sup> ) Weight per m <sup>2</sup> Poids par m <sup>2</sup> Peso por m <sup>2</sup>
312004	90	0,115	2,6
312010	180	0,138	3,1

Pesos aproximados / Approximate wights / Poids approximatifs / Pesos aproximados

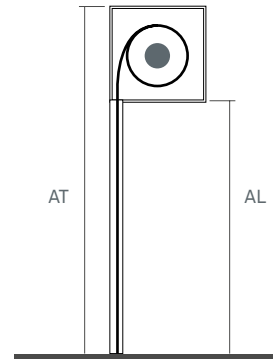

## ■ Diámetro de enrollamiento

Rolling dimaters / Diamètres d'enroulement / Diâmetros de enrolamento

Altura ( AL ) ( mm ) / Height / Hauteur	600	800	1000	1200	1400	1600	1800	2000	2200	2400	2600	2800	3000
Nº de lamas / Number of slats / Nombre de lames / N.º de lâminas	12	17	21	26	30	35	39	43	48	52	57	61	66
Eje Ø 40 Shaft / Axe / Eixo	105	115	120	130	140	145	150	160	165	170	175	180	190
Eje Ø 60 Shaft / Axe / Eixo	115	120	125	140	145	155	155	165	170	175	185	190	195

### ASPECTOS CONTEMPLADOS PARA EL CÁLCULO DE DIÁMETRO

- Se deben estimar dos lamas más que la expuesta para cada altura de luz, que se quedarán dentro del cajón
- Tirante revestido reforzado autoanclaje
- Remate interior

## ■ Altura máxima de persiana por tipo de cajón (m)

Max. roller shutter height for type of box / Hauteur max. de volet roulant par type de coffre / Altura máxima de persiana consoante ao tipos de caixa

Altura ( AT ) ( m ) Height / Hauteur	CAJÓN PREMIUM			CAJÓN ESTÁNDAR				CAJÓN ALUMINIO 2P / 4P			
	155	185	200	UNIVERSAL		200	225	137	165	180	205
Eje Ø 40 Shaft / Axe / Eixo	1,55	2,55	2,65	1,55	2,55	2,65	3,60	1,35	2,15	2,65	3,55
Eje Ø 60 Shaft / Axe / Eixo	1,35	2,35	2,45	1,35	2,35	2,45	3,55	1,30	2,10	2,55	3,40

Las medidas pueden variar dependiendo del tamaño de eje y paño, se incluye cajón y terminal / Measurements may vary depending on shaft and shutter size, and they include the box and the end slat / Les dimensions peuvent varier en fonction de la dimension de l'axe et du tablier, et incluent coffre et lame finale. As medidas podem variar dependendo do tamanho do eixo e do pano, e inclui caixa e terminal.

## ■ Tapón compatible

Compatible end cap / Bouchon compatible / Bloqueador lateral compatível

111345 TAPÓN TERMICUR 45 / MINICUR 43 / TERMILUM 45

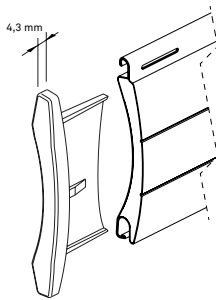

## ■ Descuentos

Discounts / Réductions / Descontos

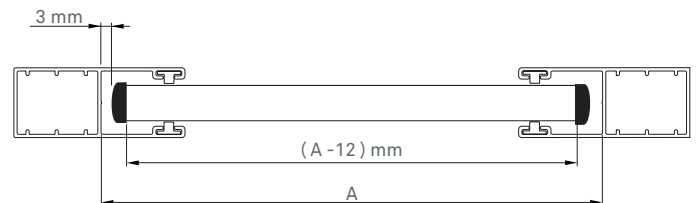

## ■ Tirante

Springs / Attaches / Laço

### 111424 REVESTIDO REFORZADO AUTOANCLAJE

Reinforced covered to clip  
Revetu renforcé à clipper  
Revestido reforço Auto

### 111824 METALICO AUTOANCLAJE

Metallic to clip  
Métallique à clipper  
Metalico auto-ancoragem

### 111473 RÍGIDO 1E50/60CTL9

Rigid 1E50 / 60CTL9  
Rigide 1E50 / 60CTL9  
Rijo 1E50 / 60CTL9

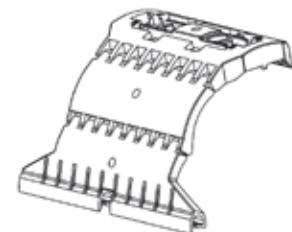
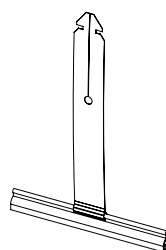
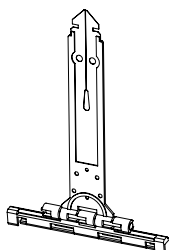

### ■ Guías de aluminio recomendadas

Recommended aluminum guides/ Coulisses en aluminium recommandées  
 Guias em alumínio recomendadas

#### 308029 H - 25

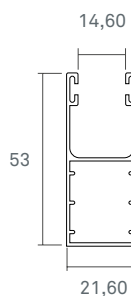

#### 308031 H - 40

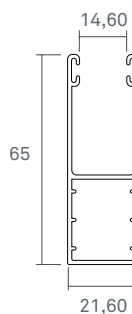

### ■ Felpudo Compatible

Compatible brush / Brosse compatible

#### 311047 FELPUDO 7 X 5.5

Brush guide / Brosse Coulisse

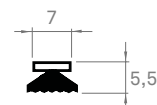

<b>Material</b> Matière	<b>Auminio</b> 6063T5
<b>Espesor aprox. (mm)</b> Approx. thickness/ Épaisseur approx. / Grossura nominal	1,0
<b>Peso m. lineal (g)</b> Linear m. weight / Poids m. linéaire / Peso linear	339
<b>Perímetro total (mm)</b> Total perimeter / Périmètre total / Perímetro total	334

<b>Material</b> Matière	<b>Auminio</b> 6063T5
<b>Espesor aprox. (mm)</b> Approx. thickness/ Épaisseur approx. / Grossura nominal	1,3
<b>Peso m. lineal (g)</b> Linear m. weight / Poids m. linéaire / Peso linear	658
<b>Perímetro total (mm)</b> Total perimeter / Périmètre total / Perímetro total	376

<b>Material</b> Matière	<b>PP + PVC</b>
----------------------------	-----------------

### ■ Guías de PVC recomendadas

Recommended PVC guides/ Coulisses en PVC recommandées  
 Guias em PVC recomendadas

#### 310015 PVC 45 x 60

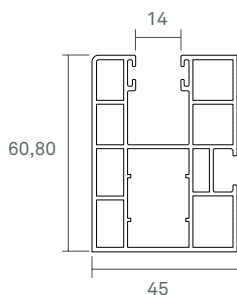

#### 310089 PVC 28 x 65

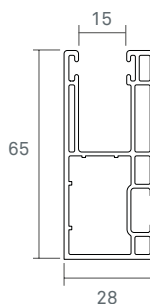

<b>Material</b> Matière	<b>PVC</b>
<b>Espesor aprox. (mm)</b> Approx. thickness/ Épaisseur approx. / Grossura nominal	1.2
<b>Peso m. lineal (g)</b> Linear m. weight / Poids m. linéaire / Peso linear	732
<b>Perímetro total (mm)</b> Total perimeter / Périmètre total / Perímetro total	817

<b>Material</b> Matière	<b>PVC</b>
<b>Espesor aprox. (mm)</b> Approx. thickness/ Épaisseur approx. / Grossura nominal	1.5
<b>Peso m. lineal (g)</b> Linear m. weight / Poids m. linéaire / Peso linear	548
<b>Perímetro total (mm)</b> Total perimeter / Périmètre total / Perímetro total	586

## ■ Remates

End slats / Lames finales / Remate

### 313032 AL DOBLE

Doble / Duplo / Doble

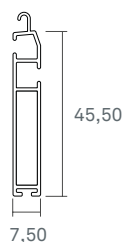

Material Matière	Auminio 6063T5
<b>Espesor aprox. (mm)</b> Approx. thickness/ Épaisseur approx. / Grossura nominal	0,9
<b>Peso m. lineal (g)</b> Linear m. weight / Poids m. linéaire / Peso linear	279
<b>Perímetro total (mm)</b> Total perimeter / Périmètre total / Perímetro total	227

### 313034 AL INTERIOR

Inside / Intérieur / Interior



Material Matière	Auminio 6063T5
<b>Espesor aprox. (mm)</b> Approx. thickness/ Épaisseur approx. / Grossura nominal	0,9
<b>Peso m. lineal (g)</b> Linear m. weight / Poids m. linéaire / Peso linear	272
<b>Perímetro total (mm)</b> Total perimeter / Périmètre total / Perímetro total	223

### 313089 AL INTERIOR PEQUEÑO

Small inside / Intérieur petit  
Interior pequeno

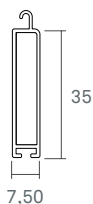

Material Matière	Auminio 6063T5
<b>Espesor aprox. (mm)</b> Approx. thickness/ Épaisseur approx. / Grossura nominal	0,9
<b>Peso m. lineal (g)</b> Linear m. weight / Poids m. linéaire / Peso linear	241
<b>Perímetro total (mm)</b> Total perimeter / Périmètre total / Perímetro total	181

### 330025 AL ANTI-TORSIÓN

Anti-torsion

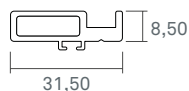

Material Matière	Auminio 6063T5
<b>Espesor aprox. (mm)</b> Approx. thickness/ Épaisseur approx. / Grossura nominal	1,5
<b>Peso m. lineal (g)</b> Linear m. weight / Poids m. linéaire / Peso linear	357
<b>Perímetro total (mm)</b> Total perimeter / Périmètre total / Perímetro total	147